



ALUMINUM
CAN RACKS **NSF**
 Full and Half Size



CR10-162



CR10-162M

Item #: _____ *Qty #:* _____
Model #: _____
Project #: _____

ALUMINUM TOP



POLY TOP



STAINLESS STEEL TOP



FEATURES:

Heavy duty welded construction.

Metal bullet feet on CR10-162 only.

4" Plate Casters with two Brakes. Standard on all Can Racks EXCEPT CR10-162 (See CR10-162M).

CONSTRUCTION:

Fully welded 1 1/4" square tubing ladder assembly.

MATERIAL:

Extruded aluminum angles.

Aluminum top .09 thickness.

MODEL #	Description	Can Capacity	
		#10	#5
CR10-162	Full Can Rack	162	216
CR10-162M	Full Can Rack with Casters	162	216
CR10-72	Aluminum Top	72	96
CR10-54	Aluminum Top	54	72
CRPL10-72	Poly Top	72	96
CRPL10-54	Poly Top	54	72
CRSS10-72	S/S Top	72	96
CRSS10-54	S/S Top	54	72



Customer Service Available To Assist You **1-800-645-3166** 8:30 am - 8:00 pm E.S.T.

Email Orders To: customer@advancetabco.com. For Smart Fabrication™ Quotes, Email To: smartfab@advancetabco.com or Fax To: 631-586-2933

NEW YORK
 Fax: (631) 242-6900

GEORGIA
 Fax: (770) 775-5625

TEXAS
 Fax: (972) 932-4795

NEVADA
 Fax: (775) 972-1578

DIMENSIONS and SPECIFICATIONS

TOL ± .500"

ALL DIMENSIONS ARE TYPICAL

FULL SIZE CAN RACKS

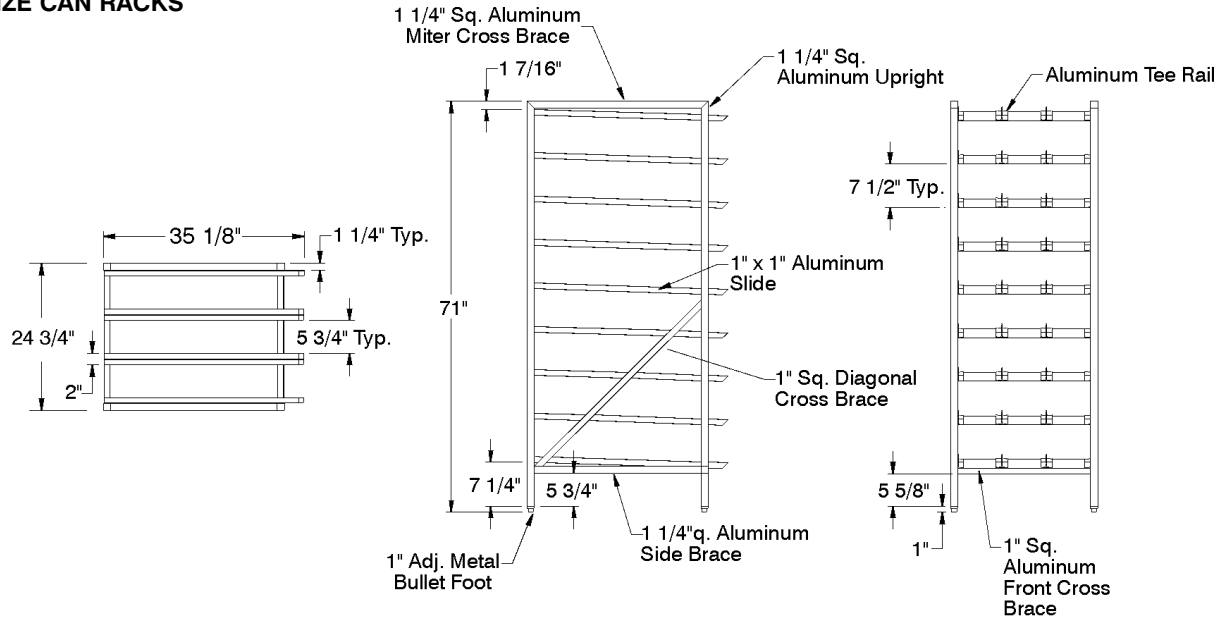

MODEL #	Description	Can Capacity		Overall Size L x W x H	Approx. Weight
		#10	#5		
CR10-162	Full Can Rack	162	216	24 3/4" x 35 1/8" x 71"	68 lbs.
CR10-162M	Full Can Rack	162	216	24 3/4" x 35 1/8" x 71"	76 lbs.

HALF SIZE CAN RACKS

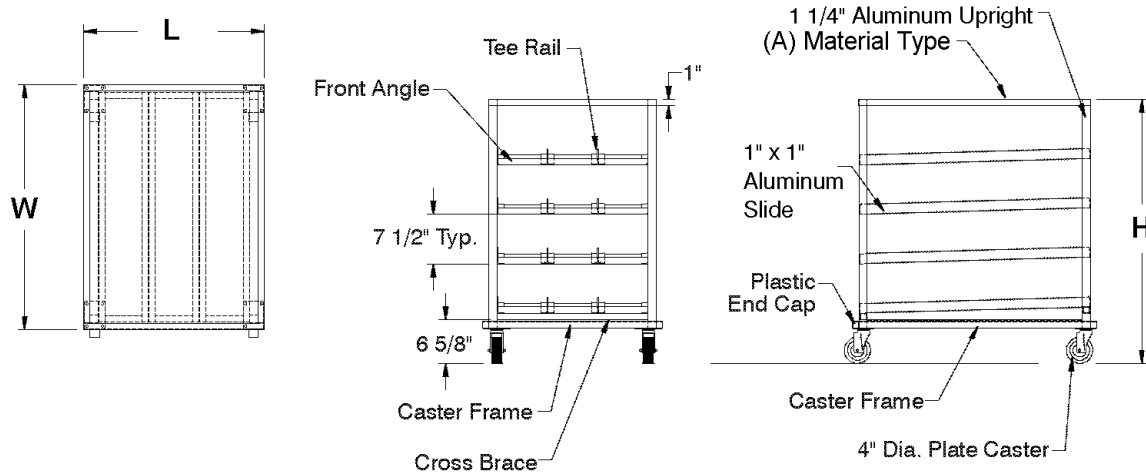

MODEL #	Rack Top Material (A)	Can Capacity		Overall Size L x W x H	Approx. Weight
		#10	#5		
CR10-72	Aluminum Top	72	96	24 3/4" x 35 1/8" x 40 1/8"	56 lbs.
CR10-54	Aluminum Top	54	72	24 3/4" x 35 1/8" x 32 5/8"	49 lbs.
CRPL10-72	Poly Top	72	96	24 3/4" x 35 1/8" x 40 1/8"	70 lbs.
CRPL10-54	Poly Top	54	72	24 3/4" x 35 1/8" x 32 5/8"	64 lbs.
CRSS10-72	S/S Top	72	96	24 3/4" x 35 1/8" x 40 1/8"	63 lbs.
CRSS10-54	S/S Top	54	72	24 3/4" x 35 1/8" x 32 5/8"	55 lbs.

