

kentfield collection-

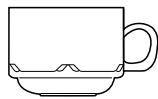

SK-35
Cup A.D. Stackable
2 3/8" / 6 cm
3 oz / 88 ml / 3 dz
10 lb / 4.5 kg



KF-1
Cup Sandra Stacking
3 3/8" / 8.6 cm
7 oz / 207 ml / 3 dz
18 lb / 8.1 kg



KF-CT
Cup Lauren Tall
3 1/2" / 8.9 cm
7 oz / 207 ml / 3 dz
21 lb / 9.5 kg



KF-17
Mug Andrew
2 7/8" / 7.3 cm
8 oz / 236 ml / 3 dz
22 lb / 10 kg

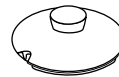

SK-CV
Bouillon / Sugar Bowl Lid
for KF / SAU
22 lb / 10 kg

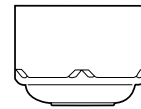

KF-4
Bouillon Stacking
3 3/8" / 8.6 cm
7 oz / 207 ml / 3 dz
16 lb / 7.2 kg

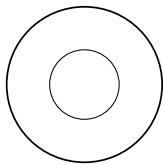

SK-36
Saucer A.D.
4 7/8" / 12.4 cm / 3 dz
8 lb / 3.6 kg

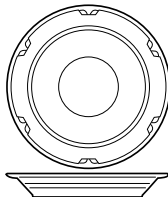

KF-2
Saucer
5 3/4" / 14.6 cm / 3 dz
16 lb / 7.2 kg

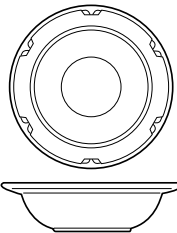

KF-11
Fruit
5" / 12.8 cm
3 oz / 88 ml / 3 dz
15 lb / 6.8 kg

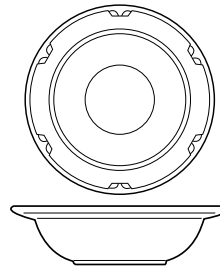

KF-10
Grapefruit
6 3/8" / 17.2 cm
11 oz / 325 ml / 3 dz
25 lb / 11.3 kg

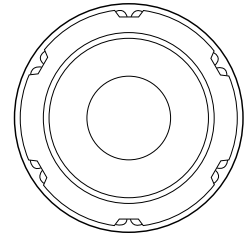

KF-3
9" / 22.9 cm
11 oz / 325 ml / 2 dz
34 lb / 15.4 kg

KF-23
12" / 30.5 cm
24 oz / 709 ml / 1 dz
36 lb / 16.3

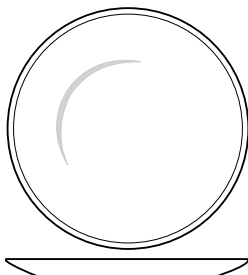

Coupe Plate

SK-22
8" / 21 cm / 2 dz
24 lb / 10.9 kg

SK-8
9" / 23 cm / 2 dz
30 lb / 13.6 kg

SK-16
10" / 26 cm / 1 dz
22 lb / 10 kg

SK-21
12" / 30.5 cm / 1 dz
31 lb / 14 kg

SK-44
14" / 35.6 cm / 1 dz
47 lb / 21.3 kg

SK-47
16" / 40.6 cm / 0.5 dz
35 lb / 15.9 kg

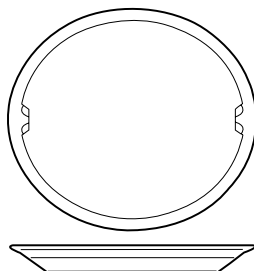

KF-99

Buffet Plate
11" / 28 cm / 1 dz
25 lb / 11.3 kg

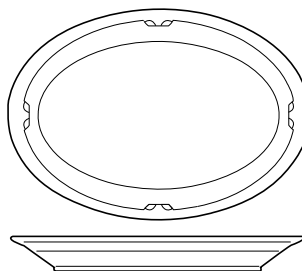

Oval Platter

KF-93
11 3/4" / 29.8 cm / 1 dz
24 lb / 10.9 kg

KF-94
14" / 35.6 cm / 1 dz
37 lb / 16.8 kg

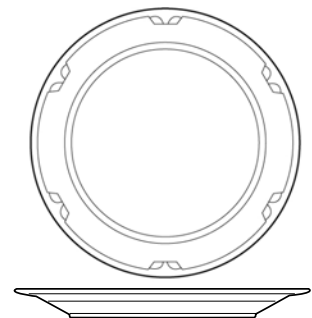

Plate

KF-6
6 1/4" / 15.9 cm / 3 dz
21 lb / 9.5 kg

KF-7
7 1/4" / 18.4 cm / 3 dz
27 lb / 12.2 kg

KF-8
9" / 22.9 cm / 2 dz
34 lb / 15.4 kg

KF-9
9 3/4" / 24.8 cm / 2 dz
38 lb / 17.7 kg

KF-16
10 3/4" / 27.3 cm / 1 dz
23 lb / 10.4 kg

KF-21
12" / 30.5 cm / 1 dz
41 lb / 18.6 kg



KF-TP
Tea Pot
15 oz / 443 ml / 3 dz
41 lb / 18.6 kg

SK-TL
Tea Pot Lid For KF-TP

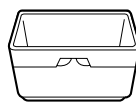

KF-PH
Sugar Packet Holder
3 1/2" / 9 cm / 4 dz
24 lb / 10.9 kg

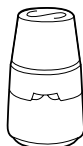

KF-SS
Salt Shaker
2 7/8" / 7.3 cm / 4 dz
9 lb / 4 kg

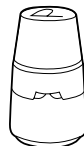

KF-PS
Pepper Shaker
2 7/8" / 7.3 cm / 4 dz
8 lb / 3.6 kg



KF-CM
Creamer
6 oz / 177 ml / 4 dz
19 lb / 8.6 kg

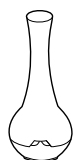

KF-BV
Bud Vase
4 1/2" / 11.5 cm / 4 dz
9 lb / 4 kg



KF-AT
Ashtray 3 Snuff
4 1/4" / 11.5 cm / 6 dz
31 lb / 14 kg

